

# Occasional Table

*buying guide*

ETHAN ALLEN®

— THE INTERIOR DESIGN DESTINATION —

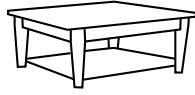

# CHOOSING A COFFEE TABLE

START WITH A SHAPE



**Rectangular coffee tables** are a great match for almost any sofa



**Round coffee tables** add visual variety and soften the angles in your room.



**Square coffee tables** make good companions for a sectional..



*Want something different?* Opt for nesting tables. Placed together, they function as a regular coffee table. When you need to, you can separate them and use them in different places.



**SCAN HERE**  
*Shop all living room furniture*

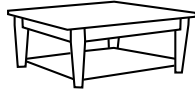

## SELECT A SIZE

To determine the best size for your coffee table, start by measuring  
1) the seat height of your sofa or sectional and 2) the length of your sofa or sectional.

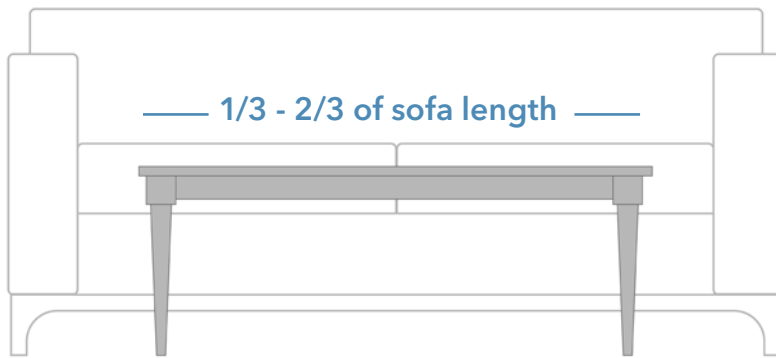

The length should be 1/2 to 2/3 the length of your sofa, or 1/2 to 2/3 the length of your longest sectional side from arm to interior corner.

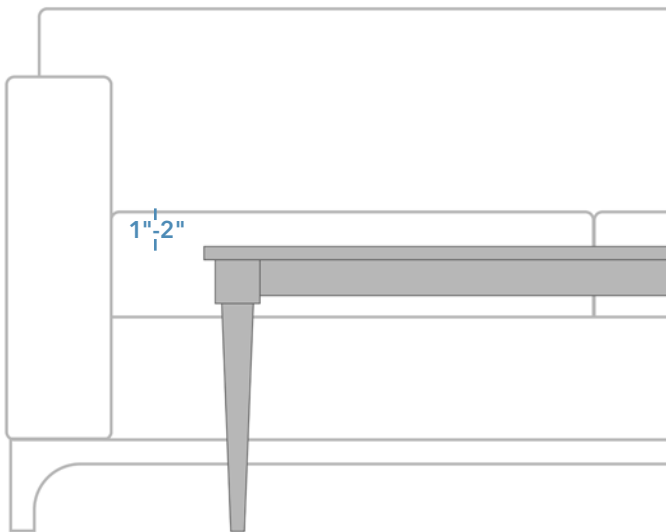

Your coffee table height should be about 1 to 2 inches lower than your sofa or sectional seat.



**SCAN HERE**

*Shop all living room furniture*

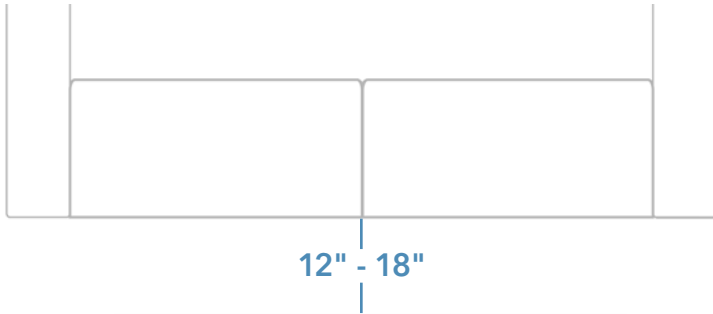
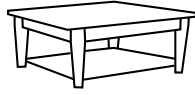

When choosing the coffee table width, make sure that when it's in place, you'll have 12 to 18 inches of walking space between your coffee table and the surrounding furniture.



*Ottomans can substitute as coffee tables* and serve as extra seating in a pinch; just be aware that an ottoman is going to be shorter than a typical coffee table places.



**SCAN HERE**

*Shop all living room furniture*

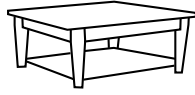

## SELECTING END TABLES

To match or not to match



End tables that contrast with your coffee table, whether they're a different shape, a different material, or just a slightly different finish, can give your living room a curated, collected look.



End tables that match your coffee table require no interior design guesswork. They're the perfect plug-and-play solution for pulling your living room décor together.

## Choosing the right size

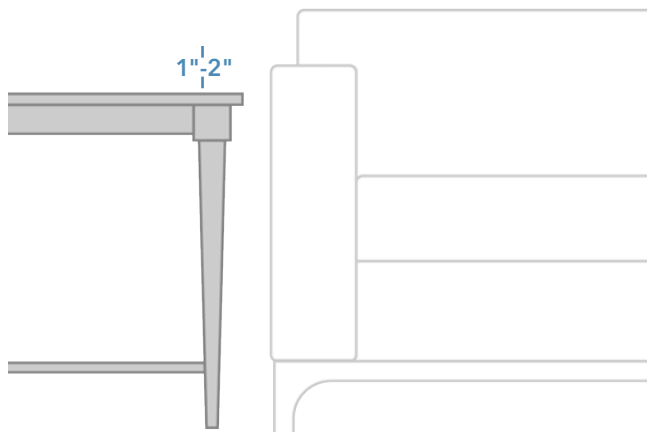

Your new end table's height should be within 1 to 2 inches, higher or lower, of your sofa or sectional arm.



**SCAN HERE**  
*Shop all living room furniture*

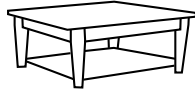

**WIDE ENOUGH FOR  
DECOR AND MORE**

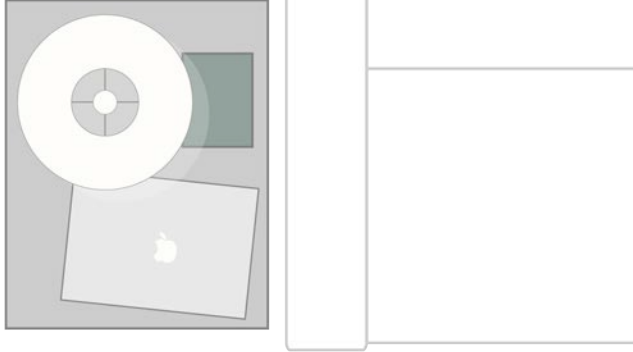

Base the width of your end table on the amount of space it can fit into and what you need it to do. If you want to put a table lamp on top, as well as have space for books and beverages, you'll need a wider table.



Some end tables can double as bedroom night tables. Make sure the top of the end table will be about even with the top of your mattress.

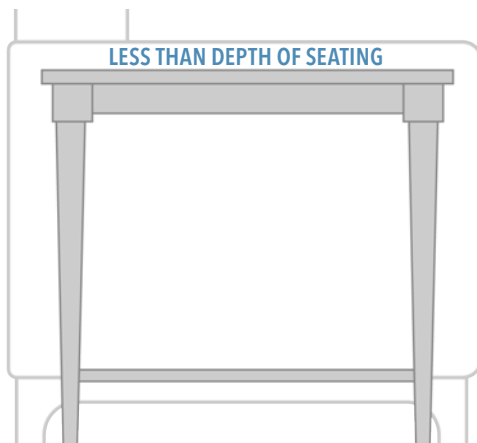

Some end tables can double as bedroom night tables. Make sure the top of the end table will be about even with the top of your mattress.



**SCAN HERE**

*Shop all living room furniture*

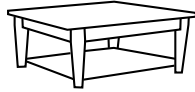

## PICKING A CONSOLE TABLE OR SOFA TABLE

### Rectangular vs. Demilune



Glenavon Wood Console Table

A rectangular console holds plenty of items on top and is easy to fit into almost any space.



Kronos Demilune Console

Want to switch things up or go for a softer look? Try a console table with a curved demilune profile.

### Open vs. Closed



Nikita Console

An open console table has a lighter, airier look, and may or may not come with one or more shelves which you can use to display collectibles.



Altan Media Cabinet

A console with a cabinet or storage drawers keeps items discreetly hidden. A small dresser or chest can also do double-duty as a closed console.



**SCAN HERE**

*Shop all living room furniture*

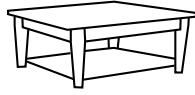

## THINK ABOUT SIZE

If your console table is going behind a sofa, it should be no taller than the back of the sofa and about 2/3 the length of the sofa.

In an entryway or hallway, any length that fits is okay. Just make sure you check the depth of the console table so it doesn't come too far forward and interfere with traffic flow.



*Looking for something as tall as a console table but less wide? A bar cart can fill those tight corners and make space for your spirits—or you can use its shelves to display and store other items.*

## Choosing the right materials



**Wood occasional tables** can go formal or casual: formal in rich, dark finishes with artisan veneer work; casual in simpler wire-brushed or distressed finishes.



**Glass-top occasional tables** have less visual weight and can help a small space feel larger.



**Stone-top occasional tables** are a great way to introduce textural variety into any space.



**Metal-top occasional tables** can give your living room a modern, industrial feel.



**SCAN HERE**

*Shop all living room furniture*



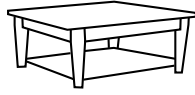

## *Ready To Shop?*

Visit a design center today and view our latest coffee table, end table and console table combinations. Speak with a designer to explore many more styles and finishes to furnish your home



**SCAN HERE**

*Shop all living room furniture*